

Vibration monitor vibro-converter MODEL-2503

Allows vibration monitoring, using various kinds of sensors

Monitoring
System

Essential safety explosion-proof monitor system

Low frequency vibration monitoring system

Low-priced system using sensor with built-in amplifier

Vibration monitoring system for co-generation, using electric charge output sensor

Vibration monitoring system using non-contact sensor



VIBRATION PICKUP
MODEL 2400A
SR. NO. 204329-2

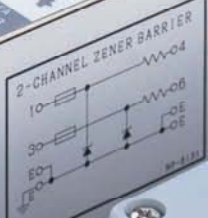

SHOWA VIBRO-CONVERTER
MODEL 2503V-BA1131

Velocity : 0 - 25mm/s

Output : 4 - 20mA

Pickup Sens : 24500V

Pickup Sx : 5.0 mV/(m/s)

Pickup Sx : 1.22V

SHOWA SOKKI CORP.

8.1000

SHOWA

AVE

Vibration monitor - Vibro-converter **MODEL-2503** series

System 1 General-purpose vibration monitor





System configuration

This type of the vibration monitor system employs an acceleration sensor built in with a robustly constructed amplifier. The sensor is sized compact and lightweight, broadband, and applicable for vibration monitoring of various types of machines. In addition, the vibration monitor employing the sensor type of 786A or 793L are best fit for monitoring a wind generator.

- Acceleration sensor
- Junction box/MODEL-TBB
- Vibro-converter/MODEL-2503
- Digital monitor/MODEL-2590B

* If the length exceeds 5 m, use TBB.



Type	Low-priced/general-purpose	General-purpose/EMC measure	General-purpose	Low frequency/high sensitivity	
Model	784A	786A	2450	793L	797L
Sensitivity m/s ² (G)	10mV (100mV)	10mV (100mV)	5mV (50mV)	50mV (500mV)	50mV (500mV)
Frequency characteristics	5Hz to 8kHz	5Hz to 8kHz	5Hz to 8kHz	1Hz to 2.3kHz	1Hz to 2.5kHz
Operating temperature limit	-50 to 120°C	-50 to 120°C	-20 to 110°C	-50 to 120°C	-50 to 120°C
Dimension	18 Hex × 46	22 Hex × 53	17 Hex × 37.5	25.4 Dia. × 61	26.7 Dia. × 30.5
Appearance					

* Models of 784A, 786A, 793L and 797L can have the IP-68 configuration in combination with the cable of CA2865.

System 2 Essential safety explosion-proof vibration monitor

System configuration

This system employs an acceleration sensor with a built-in amplifier that complies with Exia II CT4 or an essential explosion-proof vibration monitor with safety device. This explosion-proof system is sized compact and low-priced to offer.

- Acceleration sensor
- Safety retainer (barrier)/NZB2-26R430
- Vibro-converter/MODEL-2503
- Digital monitor/MODEL-2590B

Main features

Type	Essential safety explosion-proof
Model	2450EX
Sensitivity m/s ² (G)	5mV (50mV)
Frequency characteristics	2Hz to 8kHz
Operating temperature limit	-20 to 80°C
Dimensions/mass	21 Hex × 40/76g



Appearance: 

System 3 Vibration monitor using a sensor specifically for low frequencies

System configuration

This vibration monitor employs an acceleration sensor with a built-in amplifier that has a high sensitivity and superior characteristics in low frequency ranges, allowing displacement measurement from as low as 2 Hz.

- Low-frequency sensor/MODEL-2400A
- Vibro-converter/MODEL-2503
- Digital monitor/MODEL-2590B

Main features

Type	Low frequency/high sensitivity
Model	2400A
Sensitivity m/s ² (G)	100mV (1000mV)
Frequency characteristics	1 to 500Hz
Operating temperature limit	-20 to 70°C
Mass	200g



Appearance: 

Specifications of MODEL-2503

Model	2503*-00*-***	2503*-00*-***	2503*-03*-***	2503*-00*-***	2503*-02*-***	2503*-2*-***
Type	General-purpose system Specifications in acceleration sensor with built-in amplifier	For essential safety explosion-proof	For electric charge output sensor for high-temperature/high acceleration	For sensor specifically for low-frequency	For sensor specifically for low-frequency (Voltage driven)	For non-contact sensor
Sensor used	MODEL-784A	MODEL-2450EX	MODEL-376, 2304A	MODEL-793L,797L	MODEL-2400A	S-10A SSC-7510 (pre-amplifier)
Measurement mode	Acceleration (A), velocity (V) and displacement (D)					Displacement (D)
Frequency range	Acceleration	5Hz to 8kHz		1Hz to 8kHz		—
	Velocity	10Hz to 1kHz		2Hz to 1kHz		—
	Displacement	10Hz to 700Hz		2Hz to 700Hz		DC to 20kHz
Filter	As a standard specification, a best suited LPF can be built in for each mode, and any LPF or HPF can be allowed to designate.					
AC output	± 2 V/full scale					
DC output	4 to 20 mA/0 to full scale					
Power	24 VDC (18 to 30 VDC), 50 mA, 15 VA max					

Cable assembly

Model	Name	Input connector	Cable model	Output connector	Suitable sensor or amplifier	Appearance diagram
CA4442	Converter cable	R04-P5M	MVVS0.2×4	M3.5 crimping × 5	2503	①
CA1232	Junction cable	M3.5 crimping × 2	2.5D-2V	M3.5 crimping × 2	NZB2-26R430, TBB	②
CA4515	Sensor extension cable	R01-06J9-6F	4-core shield	R01-01PQ-6M	2400A	③
CA1532	Sensor cable	R04-P2M	2.5D-2V	M3.5 crimping × 2	2450EX, NZB2-26R430	④
	Barrier cable	M3.5 crimping × 2	2.5D-2V	R04-P2M	2450EX, NZB2-26R430	
CA1534	Sensor cable	TNC	2.5D-2V	R04-P2M	2450	⑤
CA2862	Sensor cable	R6W (IP-64)	J96	R04-P2M	784A, 786A, 793L, 797L	⑥
CA2863	Sensor cable	R6W (IP-64)	J96	M3.5 crimping × 2	784A, 786A, 793L, 797L	⑦
CA2865 (for waterproof)	Sensor cable	R6Q (IP-68)	J96	R04-P2M	784A, 786A, 793L, 797L	⑧
R1-2-J3 (for high temperature)	Sensor cable	10-32UNF	Low-noise cable	BNC	376	⑨
CA2656	Sensor extension cable	M3.5 crimping terminal	Sunlight SX	R04-P2M	784A, 786A, 793L, 797L	⑩

Appearance diagram of cable assembly

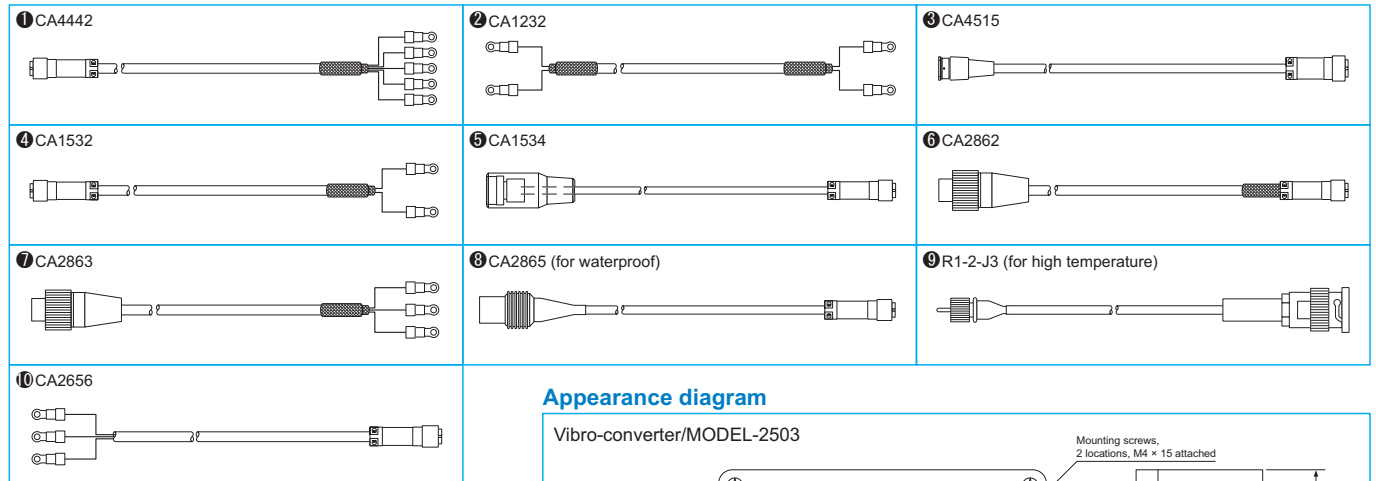

Appearance diagram

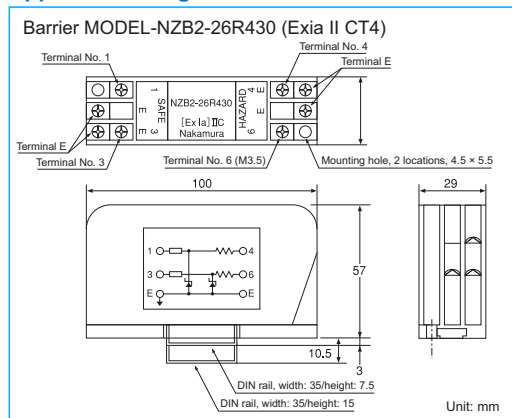

Appearance diagram

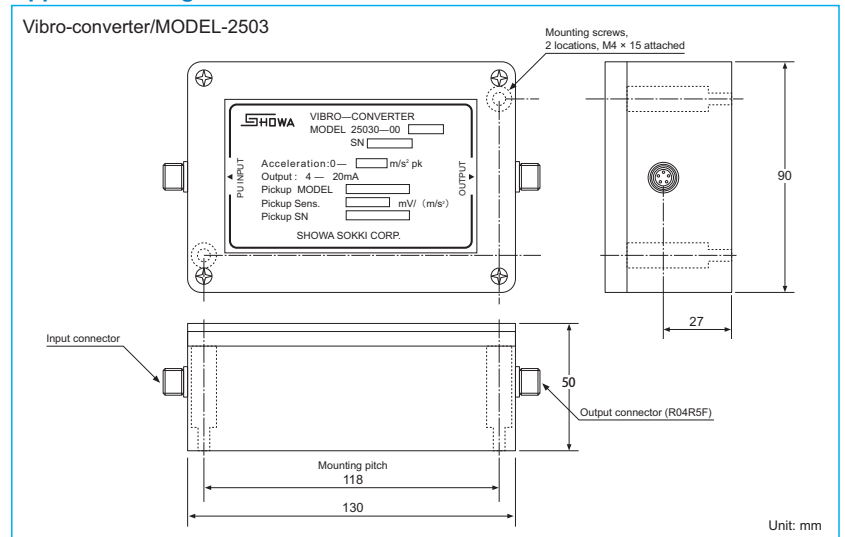

* Specifications and designs presented in the product catalog are subject to change without notice for period improvement purposes.

SHOWA Respond to the needs; "safe and comfortable"

SHOWA SOKKI CORPORATION

■ Head Office:
1-5-9 Kandaizumi-cho, Chiyoda-ku, Tokyo, 101-0024 JAPAN.
Phone: 03-3866-3210 Fax: 03-3866-3060

■ Factory
1547-1 Takao-cho, Hachioji, Tokyo, 193-0844 JAPAN.
Phone: 0426-64-3232 Fax: 0426-64-3276
http://www.showasokki.co.jp/ E-mail: eigyo@showasokki.co.jp

Agent: